

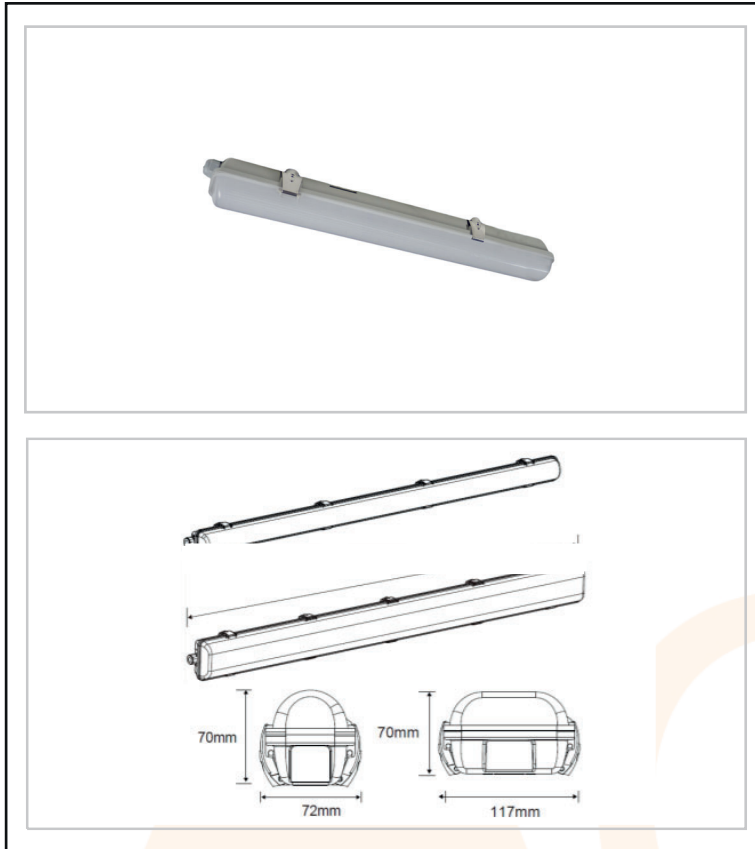

AC447210

20W LED corrosion proof, IP65

- Suitable for workshops, garages, warehouses, car parks, farm buildings, wet areas
- LED replacement for 2 x 18W fluorescent corrosion proof fitting
- 50,000 hour average lamp life
- Polycarbonate housing and the diffuser providing high impact protection rating of IK08
- Complete with stainless steel clips and screws
- High efficacy of 114lm/W
- Wide ambient temperature operation range of -20°C +40°C
- Suitable for switching by PIR, Microwave or Photocell



Technical Specification

Cap Type	LED
Total Power	18.9
Lumens (lm)	2160
Beam Angle	120
Lamp Life (Hrs)	50000
Number of LEDs	80 (16S5P)
Comparable To	2x18W Fluorescent
CRI	80
CCT (K)	4000
Efficacy (lm/cctW)	114
Lux at 1m	640
Power Factor	0.9
Colour	Grey
Width (mm)	117
Length (mm)	650

4-AC447210-2021-V1