

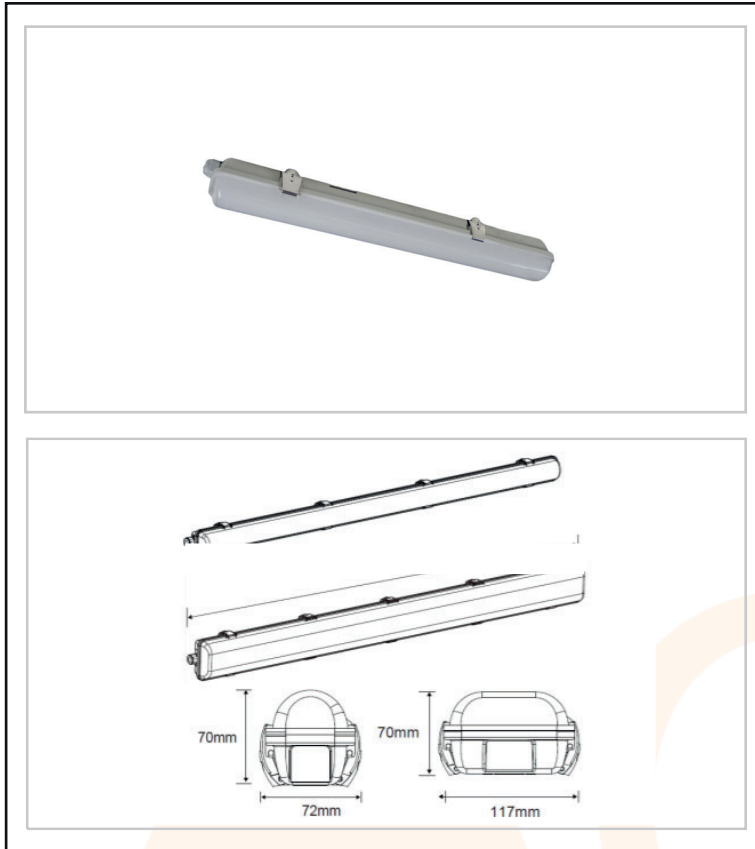

AC447211

20W LED corrosion proof, IP65

- Suitable for workshops, garages, warehouses, car parks, farm buildings, wet areas
- LED replacement for 1x 36W fluorescent corrosion proof fitting
- 50,000 hour average lamp life
- Polycarbonate housing and the diffuser providing high impact protection rating of IK08
- Complete with stainless steel clips and screws
- High efficacy of 119lm/W
- Wide ambient temperature operation range of -20°C +40°C
- Suitable for switching by PIR, Microwave or Photocell



Technical Specification

Cap Type	LED
Total Power	18.9
Lumens (lm)	2250
Beam Angle	140
Lamp Life (Hrs)	50000
Number of LEDs	80 (16S5P)
Comparable To	1x 36W fluorescent
CRI	80
CCT (K)	4000
Efficacy (lm/cctW)	119
Lux at 1m	590
Power Factor	0.9
Colour	Grey
Width (mm)	72
Length (mm)	1250

4-AC447211-2021-V1