

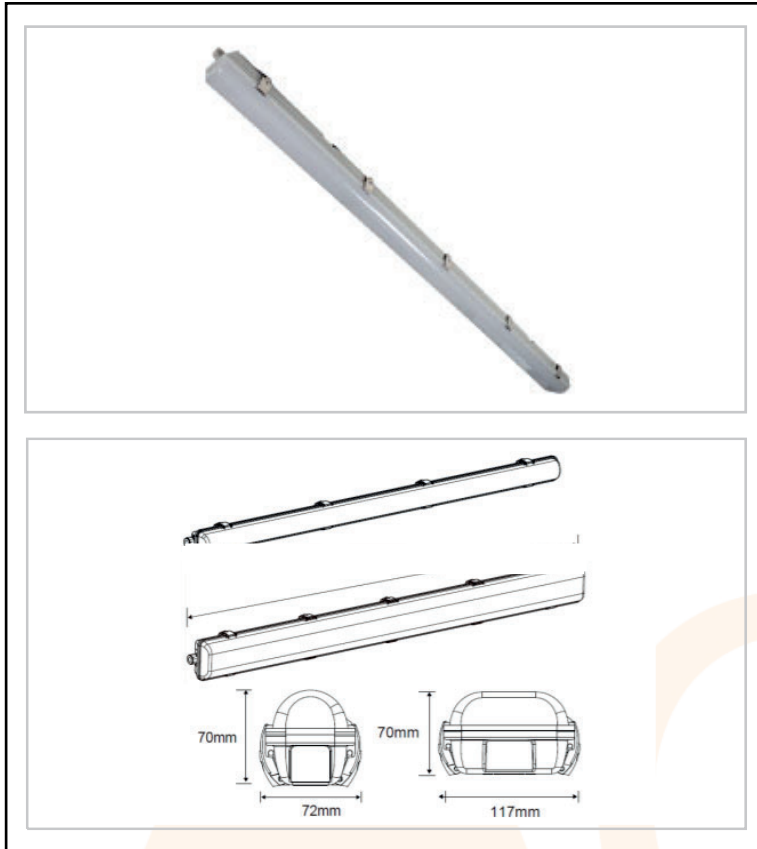

AC447216

70W LED corrosion proof, IP65

- Suitable for workshops, garages, warehouses, car parks, farm buildings, wet areas
- LED replacement for 2x 70W fluorescent corrosion proof fitting
- 50,000 hour average lamp life
- Polycarbonate housing and the diffuser providing high impact protection rating of IK08
- Complete with stainless steel clips and screws
- High efficacy of 102lm/W
- Wide ambient temperature operation range of -20°C +40°C
- Suitable for switching by PIR, Microwave or Photocell



Technical Specification	
Cap Type	LED
Total Power	69.6
Lumens (lm)	7120
Beam Angle	120
Lamp Life (Hrs)	50000
Number of LEDs	270 (15S18P)
Comparable To	2x 70W fluorescent
CRI	80
CCT (K)	4000
Efficacy (lm/cctW)	102
Lux at 1m	2070
Power Factor	0.97
Colour	Grey
Width (mm)	117
Length (mm)	1850

4-AC447216-2021-V1